

THE PROPERTY OF THE DRAWING IS ESTABLISHED BY LAW. IT IS FORBIDDEN TO PRODUCE OR SHOW IT TO THIRD PART. WITHOUT A WRITTEN AGREEMENT.

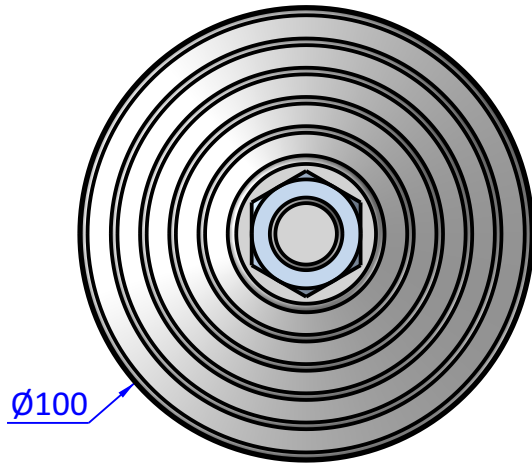
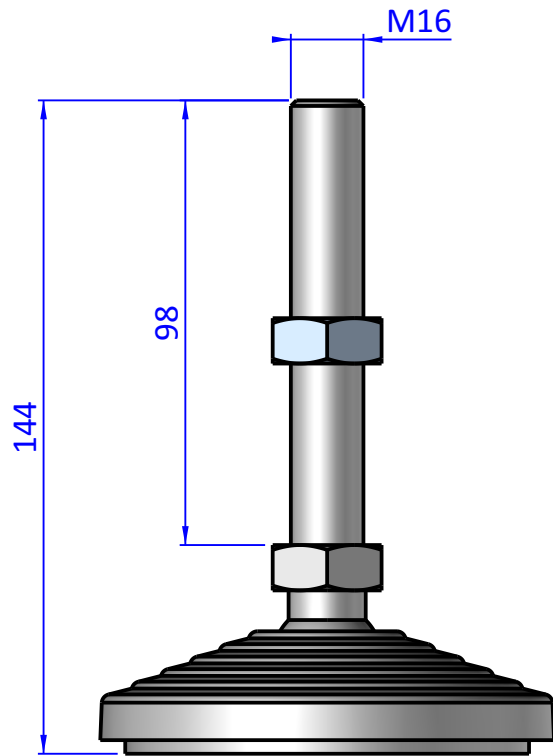
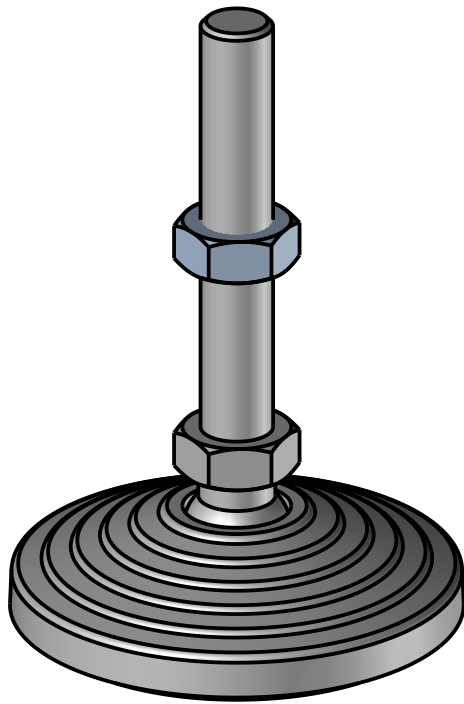

Format A4 UNI 936-76	GENERAL TOLERANCE UNI - ISO 2768 CLASSE f	DESCRIPTION PRO.084.402.006	DESIGNED FROM FPS Automation		REVIEW A
			DATE 24/03/2026	WEIGHT 0,459kg	
			CODE PRO.084.402.006		